

Name : _____

Score : _____

Volume of Triangular Prism

Find the volume of each triangular prism.

1)

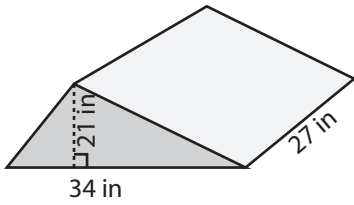

Volume = _____

2)

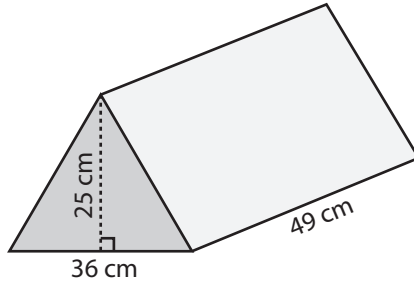

Volume = _____

3)

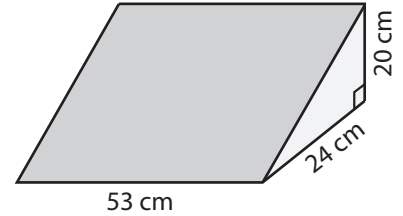

Volume = _____

4)

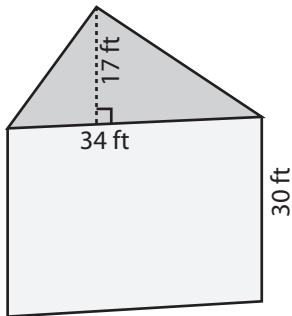

Volume = _____

5)

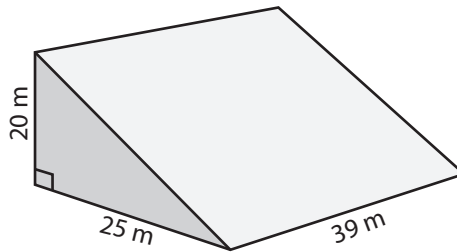

Volume = _____

6)

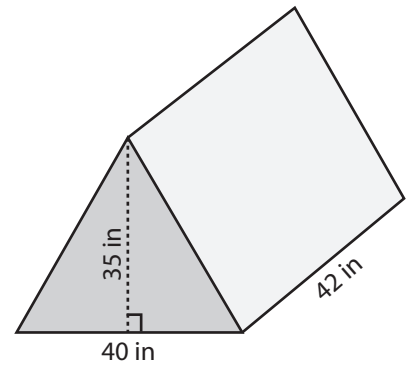

Volume = _____

7)

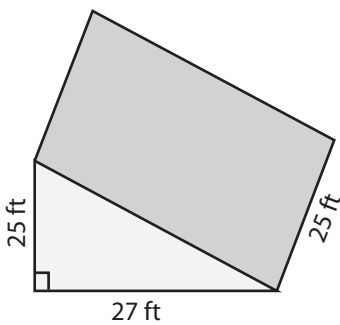

Volume = _____

8)

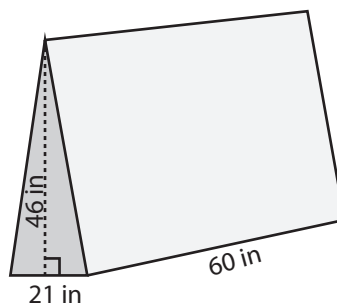

Volume = _____

9)

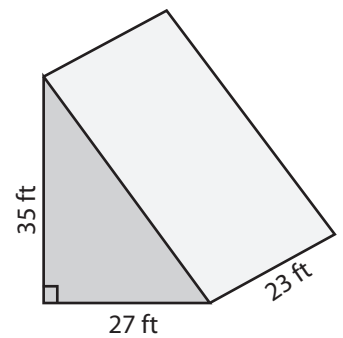

Volume = _____

Name : _____

Score : _____

Answer Key

Find the volume of each triangular prism.

1)

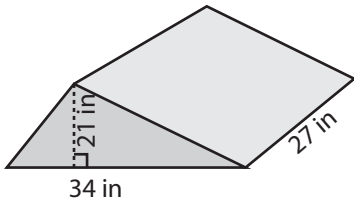

Volume = 9639 in³

2)

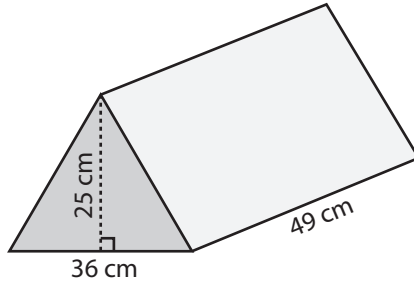

Volume = 22050 cm³

3)

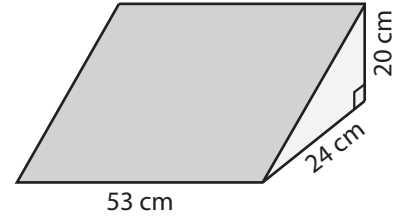

Volume = 12720 cm³

4)

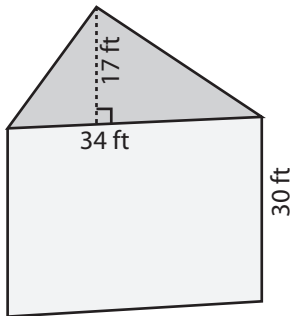

Volume = 8670 ft³

5)

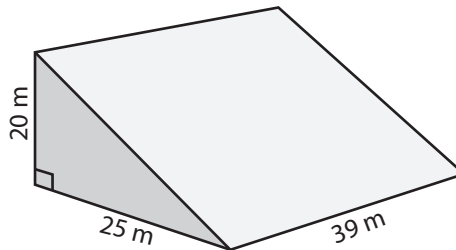

Volume = 9750 m³

6)

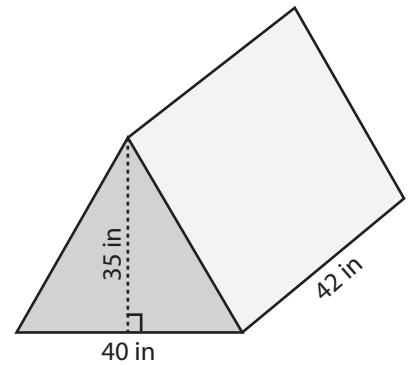

Volume = 29400 in³

7)

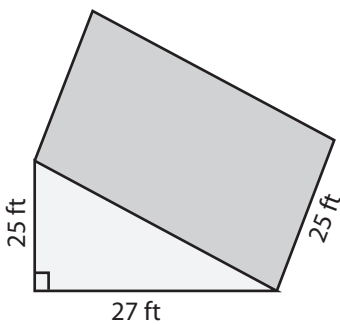

Volume = 8437.5 ft³

8)

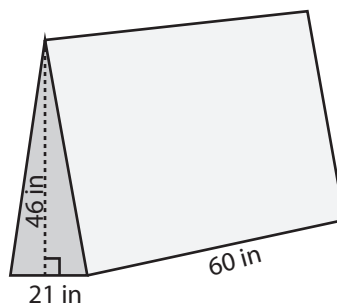

Volume = 28980 in³

9)

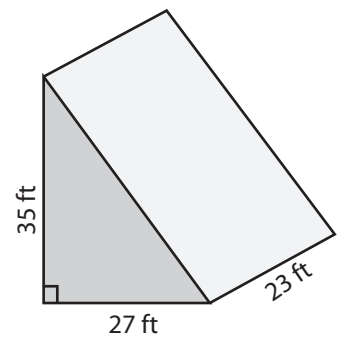

Volume = 10867.5 ft³